



— electronic components GmbH —
/ MEDIA TECHNOLOGY



5-8 February 2019
Amsterdam, RAI, NL

**Integrated
Systems
Europe**

Visit us at hall 12 - booth F110

MEDIEN-TECHNIK MEDIA TECHNOLOGY

2019

Control | Signal Management | Cable Solutions | Connect | Install | Customizing

NEWS

Adapter Ring

New patented Adapter Ring series

Make sure that your adapters are at the right place! Patented Locking Clip which can be mounted on each HDMI cable. All Adapters on braided steel wire. Short adapters and also pigtail versions available.



| Part Number | Description | DisplayPort 1080P | DisplayPort 4K60P | Mini DisplayPort 1080P | Mini DisplayPort 4K60P | HDMI-C (Mini) 4K60P | HDMI-D (Micro) 4K60P | DVI-D single link 18+1 1080P | DisplayPort 1080P | DisplayPort 4K60P | Mini DisplayPort 1080P | Mini DisplayPort 4K60P | HDMI-C (Mini) 4K60P | HDMI-D (Micro) 4K60P | DVI-D single link 18+1 1080P | USB-C 4K60P |
|---------------|--------------------------------------------------------------------|-------------------|-------------------|------------------------|------------------------|---------------------|----------------------|------------------------------|-------------------|-------------------|------------------------|------------------------|---------------------|----------------------|------------------------------|-------------|
| CK-ADR-A01 | Adapter ring with 2 adapter, short type, resolution 1080P | X | | X | | | | | | | | | | | | |
| CK-ADR-A01-4K | Adapter ring with 2 adapter, short type, resolution 4K60P | | X | | X | | | | | | | | | | | |
| CK-ADR-A02 | Adapter ring with 4 adapter, short type, resolution 1080P | X | | X | | X | X | | | | | | | | | |
| CK-ADR-A02-4K | Adapter ring with 4 adapter, short type, resolution 4K60P | | X | | X | X | X | | | | | | | | | |
| CK-ADR-A03 | Adapter ring with 3 adapter, short type, resolution 1080P | X | | X | | | | | | | | | | | | X |
| CK-ADR-A03-4K | Adapter ring with 3 adapter, short type, resolution 4K60P | | X | | X | | | | | | | | | | | X |
| CK-ADR-A04 | Adapter ring with 5 adapter, short type, resolution 1080P | X | | X | | X | X | X | | | | | | | | |
| CK-ADR-A04-4K | Adapter ring with 5 adapter, short type, resolution 4K60P | | X | | X | X | X | X | | | | | | | | |
| CK-ADR-A05 | Adapter ring with 5 adapter, short type, resolution 1080P | X | | X | | X | X | | | | | | | | | X |
| CK-ADR-A05-4K | Adapter ring with 5 adapter, short type, resolution 4K60P | | X | | X | X | X | | | | | | | | | X |
| CK-ADR-A07-4K | Adapter ring with 4 adapter, short type, resolution 4K60P | | X | | X | X | | | | | | | | | | X |
| CK-ADR-A08 | Adapter ring with 6 adapter, short type, resolution 1080P | X | | X | | X | X | X | | | | | | | | X |
| CK-ADR-A08-4K | Adapter ring with 6 adapter, short type, resolution 4K60P | | X | | X | X | X | X | | | | | | | | X |
| CK-ADR-P01 | Adapter ring with 2 adapter, pigtail type, resolution 1080P | | | | | | | | X | | X | | | | | |
| CK-ADR-P01-4K | Adapter ring with 2 adapter, pigtail type, resolution 4K60P | | | | | | | | | X | | X | | | | |
| CK-ADR-P02 | Adapter ring with 4 adapter, pigtail type, resolution 1080P | | | | | | | | X | | X | | X | X | | |
| CK-ADR-P02-4K | Adapter ring with 4 adapter, pigtail type, resolution 4K60P | | | | | | | | | X | | X | X | X | | |
| CK-ADR-P03 | Adapter ring with 3 adapter, pigtail type, resolution 1080P | | | | | | | | X | | X | | | | | X |
| CK-ADR-P03-4K | Adapter ring with 3 adapter, pigtail type, resolution 4K60P | | | | | | | | | X | | X | | | | X |
| CK-ADR-P04 | Adapter ring with 5 adapter, pigtail type, resolution 1080P | | | | | | | | X | | X | | X | X | X | |
| CK-ADR-P04-4K | Adapter ring with 5 adapter, pigtail type, resolution 4K60P | | | | | | | | | X | | X | X | X | X | |
| CK-ADR-P05 | Adapter ring with 5 adapter, pigtail type, resolution 1080P | | | | | | | | X | | X | | X | X | | X |
| CK-ADR-P05-4K | Adapter ring with 5 adapter, pigtail type, resolution 4K60P | | | | | | | | | X | | X | X | X | | X |
| CK-ADR-P06-4K | Adapter ring with 2 adapter, pigtail type, resolution 4K60P | | | | | | | | | | | X | | | | X |
| CK-ADR-P08 | Adapter ring with 6 adapter, pigtail type, resolution 1080P | | | | | | | | X | | X | | X | X | X | X |
| CK-ADR-P08-4K | Adapter ring with 6 adapter, pigtail type, resolution 4K60P | | | | | | | | | X | | X | X | X | X | X |
| CK-ADRPT | Tooling Kit for Adapter ring (2 items) | | | | | | | | | | | | | | | |
| CK-ADRP-WH | Additional clamp for adapter ring for e.g. Apple Lightning adapter | | | | | | | | | | | | | | | |

HDMI 2.0 AOC Hybrid Cable

New series of AOC hybrid cable for best performance!

- Cable with double-sided type D Micro HDMI connection, which can be easily installed
- Adapter HDMI type D female to Type A male with lock clip for safe installation in straight and right angle version available



Properties:

- Low power consumption: 250mW max., no external power required
- Compliant with HDMI 2.0 standard
- HDCP 2.2 support
- Resolution: 4K2K 60Hz 4:4:4
- Bandwith up to 18 Gbps
- EDID support
- Length: 10m / 20m / 30m / 50m / 100m



| Part Number | Description |
|------------------|-----------------------------------------------|
| CK-AOCH-10M | AOC HDMI Cable set 10m incl. 2 adapters |
| CK-AOCH-20M | AOC HDMI Cable set 20m incl. 2 adapters |
| CK-AOCH-30M | AOC HDMI Cable set 30m incl. 2 adapters |
| CK-AOCH-50M | AOC HDMI Cable set 50m incl. 2 adapters |
| CK-AOCH-100M | AOC HDMI Cable set 100m incl. 2 adapters |
| CK-AOCHDA-ADAPT | Adapter HDMI D Female to HDMI A Male straight |
| CK-AOCHDAW-ADAPT | Adapter HDMI D Female to HDMI A Male angled |

snapModular - 4 button keypad with controller

Integrated controller with network connectivity and 2 bidirectional RS232 ports



Modular controller series

The snapModular combines the power of the snapControl with our already known push button modules into a powerful keypad with an integrated media controller.

Instead of solutions from competitors you can freely scale the number of buttons you need in your application by daisy chaining snapModular together.

You are also free in installation - snapModular fits for:

- 55x55 (wall installation compatible to most suppliers)
- 45x45 (table, cable trunk, supply column, wall)
- Bachmann Table Solutions
- Schulte Table Solutions
- Special installation formats are possible upon customer request

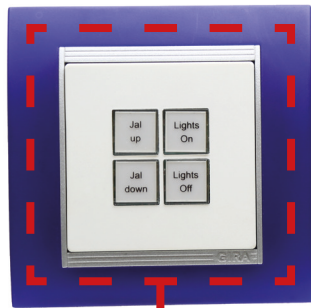

Small Master Module Controller inside!

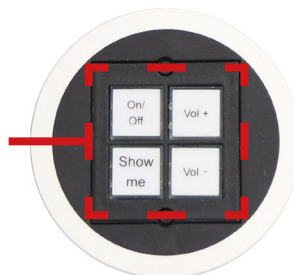

Sample Configuration

45x45 module - one master, two slaves

Installable into table, wall, cable trunk or supply column!



Master Module Central Controller

RS232



Functions

- Beamer control (e.g. power on / off)
- Display control (e.g. power on / off)



Slave Module via snapNet Extension

RS232

Connect extension modules easily over one Bus cable which feeds them with power and control signals



Functions

- Speaker (e.g. power on / off)
- Mute control
- Volume control



Slave Module via snapNet Extension

RS232

Each extension adds two serial interfaces to your control system, so it has 6 RS232 ports with 3 snapModular devices



HDBT

Functions

- Source selection (e.g. HDMI, VGA, DisplayPort)
- Device Control with RS232 over HDBaseT

snapModular

Our own developed and manufactured controller



Product Specification Master Modules

- 4 push buttons with integrated LED feedback
- RJ45 connector for TCP/IP connectivity
- Simple configuration via web browser (no drivers or setups required)
- 2 bidirectional RS232 ports
- 4 virtual TCP ports for TCP device control
- snapNet port
- Power supply included
- Software features like waits, counter, volume controller... included

Master & Slave Modules

Product Specification Slave Modules

- 4 push buttons with integrated LED feedback
- 2 bidirectional RS232 ports
- snapNet port
- Easily extends Master Modules over snapNet port
- DaisyChain up to 16 devices (a power injector is required each 6th module), which means in total 64 buttons!
- Also long distance between the modules possible.
- Even more buttons with master to master communication.

Overview

Bachmann Custom Module, module 45x45, module 55x55



| Part Number | Description |
|------------------|-----------------------------------------------------------|
| SNAPMODULAR-MB01 | Master module black, fit to Bachmann Custom module system |
| SNAPMODULAR-SB01 | Slave module black, fit to Bachmann Custom module system |

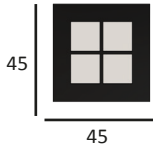

| Part Number | Description |
|-----------------------|--------------------------------|
| SNAPMODULAR-M45RWS-01 | Master module 45x45 pure white |
| SNAPMODULAR-M45ANT-01 | Master module 45x45 anthracite |
| SNAPMODULAR-S45RWS-01 | Slave module 45x45 pure white |
| SNAPMODULAR-S45ANT-01 | Slave module 45x45 anthracite |

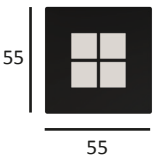

| Part Number | Description |
|------------------------|-----------------------------------------|
| SNAPMODULAR-M55RWS-01 | Master module 55x55 pure white |
| SNAPMODULAR-M55RWSG-01 | Master module 55x55 pure white glossy ✨ |
| SNAPMODULAR-M55ANT-01 | Master module 55x55 anthracite |
| SNAPMODULAR-S55RWS-01 | Slave module 55x55 pure white |
| SNAPMODULAR-S55RWSG-01 | Slave module 55x55 pure white glossy ✨ |
| SNAPMODULAR-S55ANT-01 | Slave module 55x55 anthracite |

55x55 Module Series





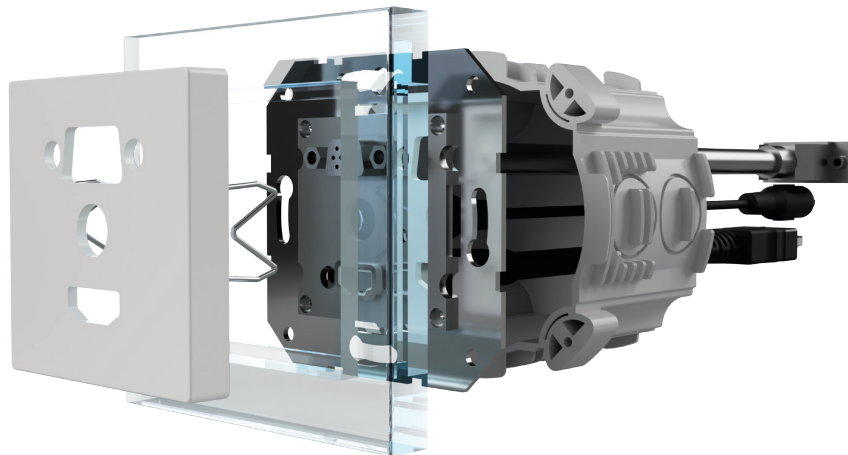



Now also in Glossy White

- Face plate design without screws
- Different colors available: pure white glossy, pure white matt, anthracite matt
- More than 100 different connection-types available
- Each connection is available in different installation versions: solder, gender changer, screw terminal, cable pigtail



Excerpt

Small excerpt, more types available

| Part Number | Description |
|------------------------------------------------------------------------------------------------------------|------------------------------------------------------------------------------------------------------------------------------------------------|
|  PS-UP-55-230XXX | 55x55 module for two Keystone module XXX: RWS = pure white, ANT = anthracite, RWSG = pure white glossy ✨ |
|  PS-UP-55-231XXX | 55x55 module for one Keystone module XXX: RWS = pure white, ANT = anthracite, RWSG = pure white glossy ✨ |
|  PS-UP-55-201XXX | 55x55 module with HDMI Pigtail 0,15m female to female, with Lock System XXX: RWS = pure white, ANT = anthracite, RWSG = pure white glossy ✨ |
|  PS-UP-55-205XXX | 55x55 module with HDMI + VGA Pigtail 0,2m, with Lock System XXX: RWS = pure white, ANT = anthracite, RWSG = pure white glossy ✨ |
|  PS-UP-55-204XXX | 55x55 module with HDMI + DisplayPort Pigtail angled version XXX: RWS = pure white, ANT = anthracite, RWSG = pure white glossy ✨ |
|  PS-UP-55-216XXX | 55x55 module with VGA + Audio + DisplayPort Pigtail XXX: RWS = pure white, ANT = anthracite, RWSG = pure white glossy ✨ |
|  PS-UP-55-221XXX | 55x55 module with DisplayPort Pigtail 0,15m XXX: RWS = pure white, ANT = anthracite, RWSG = pure white glossy ✨ |
|  PS-UP-55-245XXX | 55x55 module with DVI 24+5 dual link Pigtail 0,2m XXX: RWS = pure white, ANT = anthracite, RWSG = pure white glossy ✨ |
|  PS-UP-55-251XXX | 55x55 module with Neutrik XLR female 3 pole with Screw Terminal XXX: RWS = pure white, ANT = anthracite, RWSG = pure white glossy ✨ |

Find more module types in our webshop or give us a call!

HDBase-T™ 5 Play™

CAT6A Ultraflex Patch Cable

New type of HDBaseT™ Patch Cable with molding type connector and following specifications:

- Plug: 2xRJ45 plug triple blade 50 gold, molded type
- Cable: Ultraflex cable CAT6A S/FTP 4x2xAWG23/1, OD=6mm UV protection, oil resistant, hardly inflammable, good mechanical resistance, cable suitable up to +105°C, Ultraflex insulation for best durability UL E499958
- Properties: Resolution up to 4K
CAT6A Channel tested (each cable with test protocol)
UL-listed
suitable for industrial use
- Color: Black
- Length: 0,5m - 30m



Overview

Available cable lengths

| Part Number | Description |
|----------------|--------------------------------|
| CK-PKHDBT-005V | HDBaseT Patch cable 0,5m black |
| CK-PKHDBT-010V | HDBaseT Patch cable 1m black |
| CK-PKHDBT-020V | HDBaseT Patch cable 2m black |
| CK-PKHDBT-030V | HDBaseT Patch cable 3m black |
| CK-PKHDBT-050V | HDBaseT Patch cable 5m black |
| CK-PKHDBT-075V | HDBaseT Patch cable 7,5m black |
| CK-PKHDBT-100V | HDBaseT Patch cable 10m black |
| CK-PKHDBT-150V | HDBaseT Patch cable 15m black |
| CK-PKHDBT-200V | HDBaseT Patch cable 20m black |
| CK-PKHDBT-250V | HDBaseT Patch cable 25m black |
| CK-PKHDBT-300V | HDBaseT Patch cable 30m black |



CONTROL

Proprietary development for simple and affordable media solutions



SIGNAL MANAGEMENT

Signal transmission (HDBaseT), switch, distribute or convert, Rextron provides the right solution



CABLE SOLUTIONS

Connection cables for the professional user, stock goods and special solutions which fit on your needs



CONNECT

Connectors, adaptors, keystone adaptors, D-Size, for every application the right connection



INSTALL

perfect installation solutions for floor, table, pillars and ceiling



CUSTOMIZING

Proprietary development for simple and affordable media solutions

EVN electronic components GmbH

Maybachstraße 39
73037 Göppingen
Germany

Telefon: +49 (0) 7161 - 60 68 6-0
Telefax: +49 (0) 7161 - 60 68 6-29

E-Mail: sales@evn-components.de
Web: www.evn-components.de
Shop: www.evn-shop.de

Technische Änderungen vorbehalten.
Subject to change without prior notice.